



MiniLEDko

PROFILE (DATASHEET) V.1 17.05.2021



We took our flagship product and made it smaller. Much smaller. We are proud to introduce you to the new Coemar product family, **Mini LEDko**. Thanks to Mini LEDko we can expand our offer and make available all the quality we offer with LEDko, in a much **smaller body**.

High power is not always necessary and this is why Mini LEDko was born. Anyone who needs a profiler with an incredible light emitted/power ratio must have our brand new Mini LEDko. We have thought of everything, from optics to mounting options, to communication protocols, to ensure that anyone can find the perfect product for their needs.

Mini Ledko

PROFILE



LENS TUBE

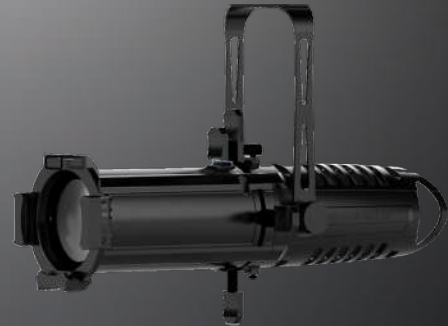

PROFILE ZOOM

Mini Ledko

We took our flagship product and made it smaller. Much smaller. We are proud to introduce you to the new Coemar product family, Mini LEDko.

Thanks to Mini LEDko we can expand our offer and make available all the quality we offer with LEDko, in a much smaller body.

High power is not always necessary and this is why Mini LEDko was born. Anyone who needs a profiler with an incredible light emitted/power ratio must have our brand new Mini LEDko. We have thought of everything, from optics to mounting options, to communication protocols, to ensure that anyone can find the perfect product for their needs.

CONFIGURATION

Mini LEDko are available in three different mounting options to fit any installation:

1. PORTABLE
2. CANOPY
3. TRACK

MAIN FEATURES



25W White COB LED (T/D version)
35W COB LED (VW version)



High CRI >95



CCT available: 2.700 K, 3.000 K, 4.000 K, 5.600 K
or Tunable white from 2700K to 5000K



High lumen flux and flat field



Swappable profile zoom 15-35° and lens tubes
between 19°-50°



Four blade framing system, each shutter
blade is adjustable for radial position and angle



360° rotation of lens and framing system



Full Body in Aluminum



RAL 9005 (black standard)



RAL custom (colour on demand)



Track / hanging / ceiling installation



European Conformity certification

[Lens Tube]

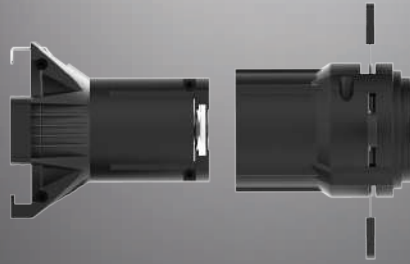

[Profile Zoom]

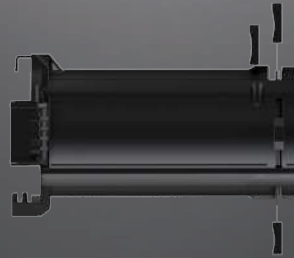

Family	Version	Optic	Barrel	Accessories	Mounting	Controls
Mini LEDko	Profile	Profile 19° Profile 26° Profile 36° Profile 50°	External Barrel with 4 Shutter Blades	Color Frame Holder Metal Gobo Holder Glass Gobo Holder	For All Versions: C-Clamp Track Canopy	For All Versions: DMX512 DALI On - Off On Board Potentiometer Bluetooth App
		Zoom 15°-35°	Integrated Barrel with 4 Shutter Blades			

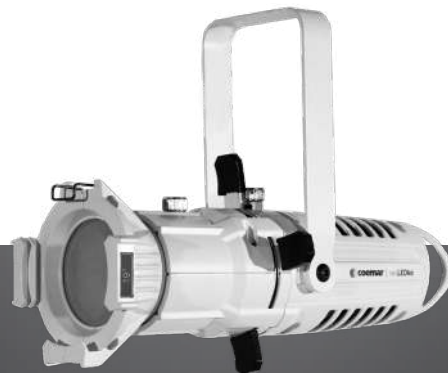

AVAILABLE ALSO IN THE WHITE VERSION

TECHNICAL DATA

Version: **Mini LEDko Profile**

General

LED Source	25W White COB LED (T/D version), 35W COB LED (VW version), 40W COB LED (RGBW, soon available)
CCT Range	3.000K, 5.600K (On request available 2.700K, 3.500K, 4.000K, 5.000K, 6.500K) 2.700K to 5.000K (VariWhite Version) 2.700K to 6.500K (RGBW version, soon available)
Color Rendition Average	CRI >96 (96 @3200K, 97 @5600K) TLCI >98 (98 @3200K, 99 @5600K) CRI >93 TLCI >95 (VariWhite version)
Available Optics	19°, 26°, 36°, 50° Lens Tube, Profile Zoom 15°-35° Four blade framing system, each shutter blade is adjustable for radial position and angle (+/- 30°)
L80 Rating (hours to 80% output)	50.000 Hours

Electrical

Voltage Input	220-240V, 50/60 Hz (on request available other voltage range)
Power Consumption	20 W typical - 0.07 A at 230 V, 0.15 A at 115 V - cosφ: 0.9
Power Connection	Integrated cable without power plug (canopy and portable version)

Thermal

Ambient Operating Temperature	0°C - +40°C (32°F - 104°F)
Cooling	Passive cooling and fan-free

Control

Control Variants	On/Off, On board potentiometer, Dali, Bluetooth App , Dmx (soon available), Wireless (optional)
RDM	DMX Setup, Fixture Status, RDM Commands (only DMX version)
Pattern projection	Yes
Accessories	Metal gobo holder (included) , glass gobo holder, color frame

Physical

Mounting Options	Track, Portable C-Clamp, Canopy
Materials	Die-cast aluminium construction (EN AB-46100 grade)
Fine Texture	High temperature powder-coated paint
Rotating Shutter	Assembly 360°
Gobo Pattern Holder	(included) - 27mm with a 22mm image area
Four Locking	Stainless steel shutters in a two-plane assembly, 0.40mm (AISI 316)
Tool-free	Tilt and beam adjustment
High-impact Resistant	Thermally insulated knobs and shutter handles
Weight	1.5 Kg / 3.3 lbs
Lenght	Body: 135 mm / 5.3 in
IP Rating	IP20

DRAWING SIZE

Track

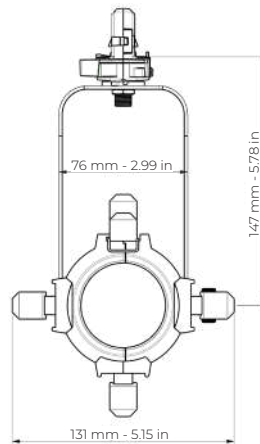
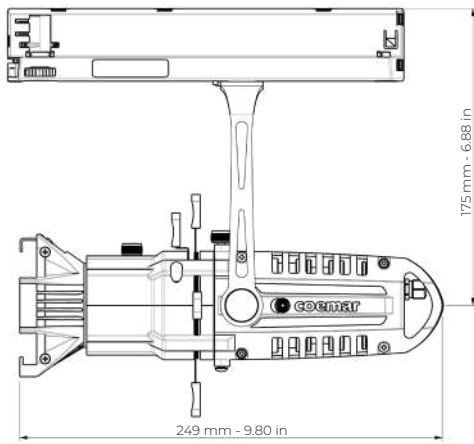

Canopy

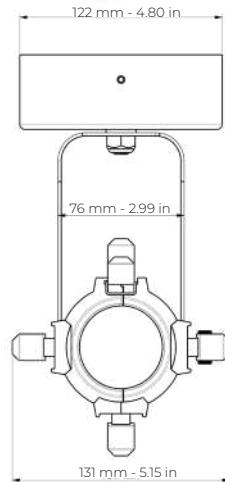
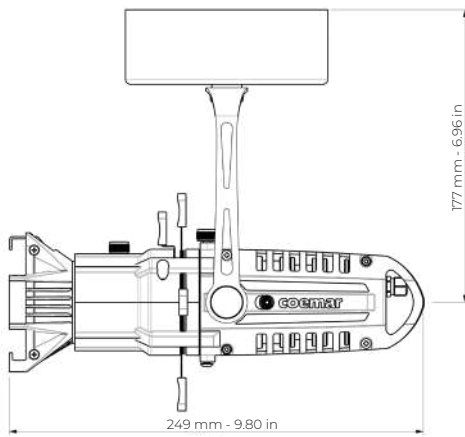

Portable

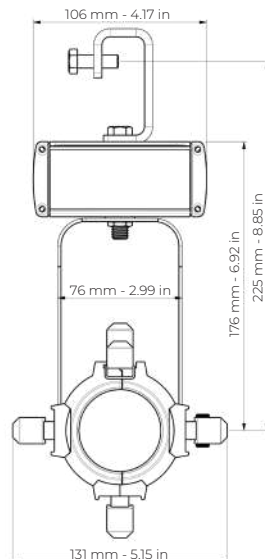
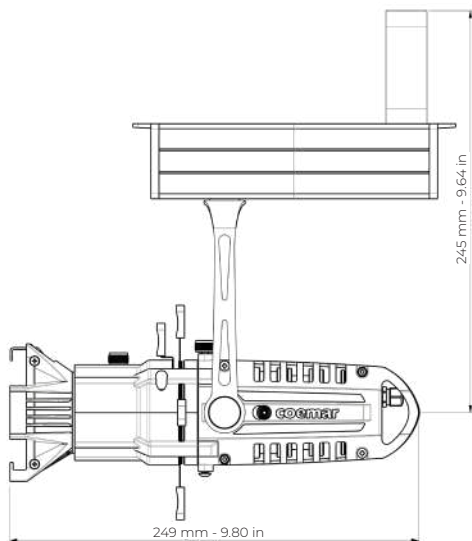

DRAWING SIZE

Track

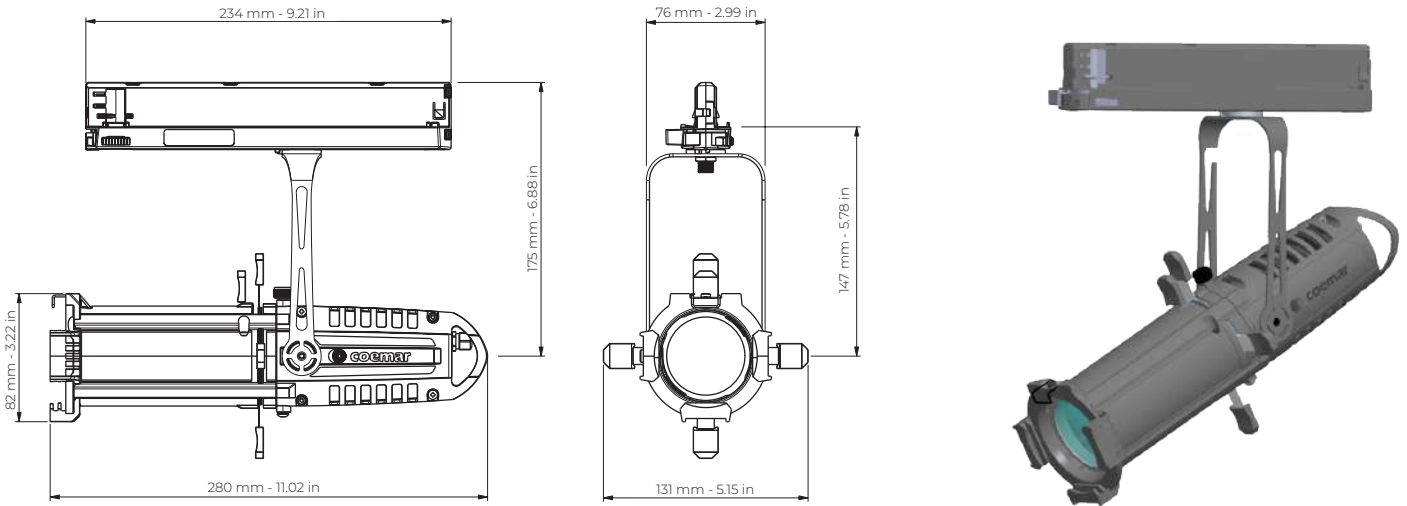

Canopy

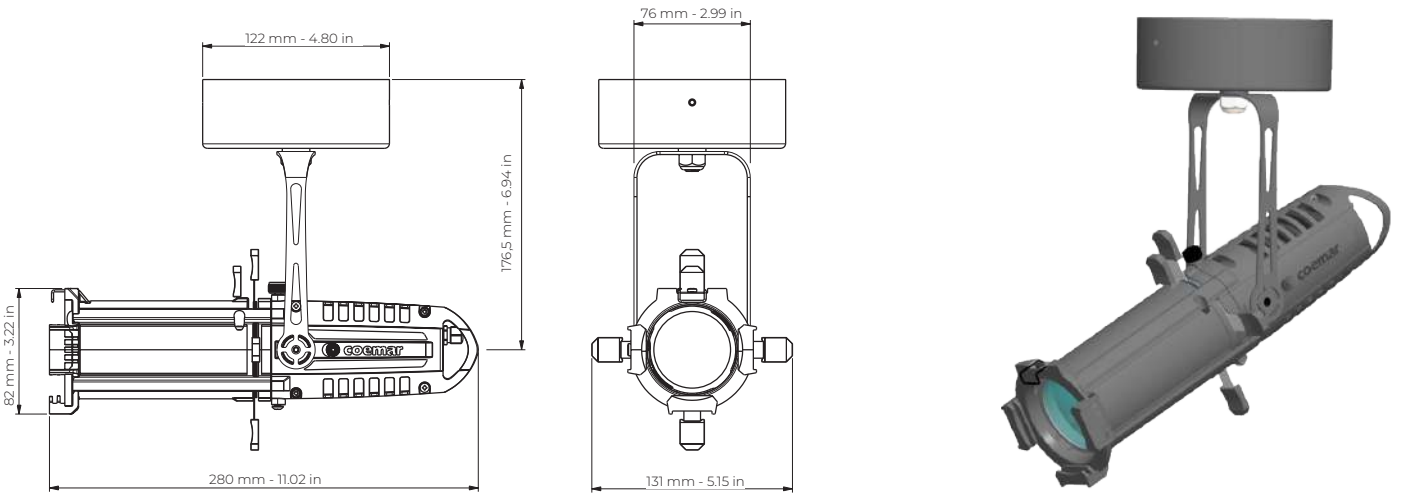

Portable

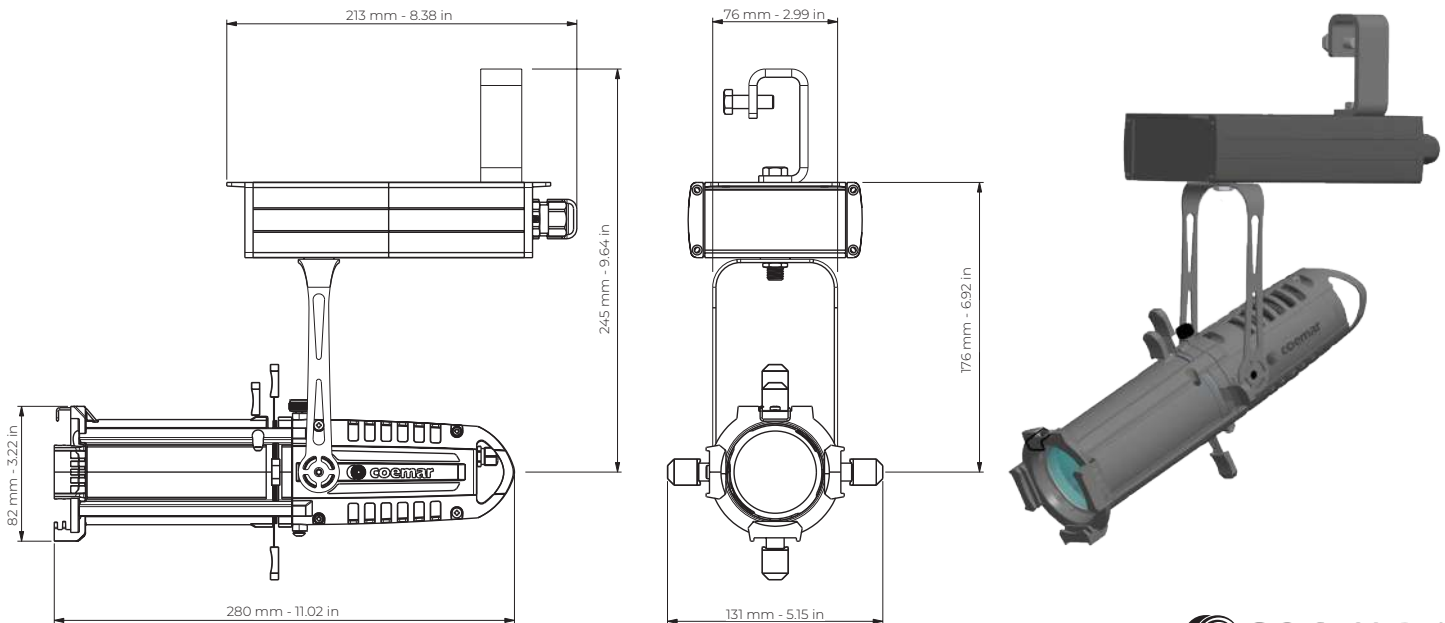

Please visit our website for the latest downloads: www.coemar.com

PHOTOMETRICAL DATA

Mini LEDko Profile Fixed White (High CRI)

Optic: Lens Tube Profile 19°

Distance (m)	1	2	3	4	5	6	7	8	9	10	
Luminous Emitance (lux)	3.000K	9.531	2.383	1059	596	381	265	195	149	118	95
	5.600K	10.503	2.626	1.167	656	420	292	214	164	130	105
Diameter ø (m)	0,30	0,60	0,90	1,20	1,49	1,79	2,09	2,39	2,69	2,99	
3.200K	CRI 96	TLCI 99									
5.000K	CRI 98	TLCI 99									

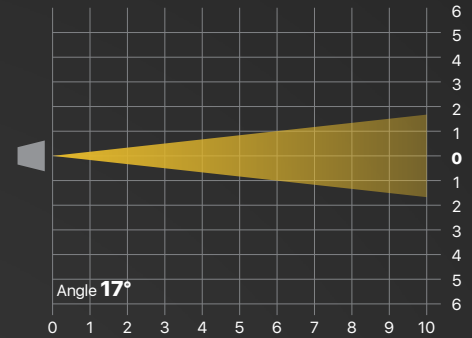

Optic: Lens Tube Profile 26°

Distance (m)	1	2	3	4	5	6	7	8	9	10	
Luminous Emitance (lux)	3.000K	4.815	1.204	535	301	193	134	98	75	59	48
	5.600K	5.688	1.422	632	356	228	158	116	89	70	57
Diameter ø (m)	0,41	0,81	1,22	1,63	2,03	2,44	2,85	3,26	3,66	4,07	
3.200K	CRI 96	TLCI 98									
5.000K	CRI 98	TLCI 99									

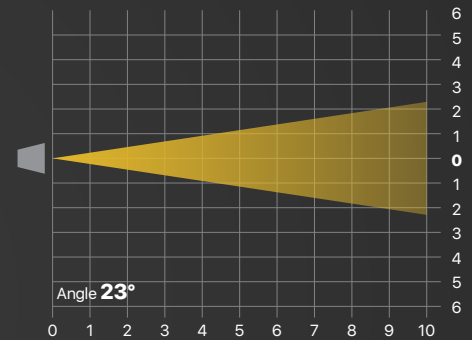

Optic: Lens Tube Profile 36°

Distance (m)	1	2	3	4	5	6	7	8	9	10	
Luminous Emitance (lux)	3.000K	3.069	767	341	192	123	85	63	48	38	31
	5.600K	3.690	923	410	231	148	103	75	58	46	37
Diameter ø (m)	0,54	1,07	1,61	2,14	2,68	3,22	3,75	4,29	4,82	5,36	
3.200K	CRI 97	TLCI 98									
5.000K	CRI 97	TLCI 99									

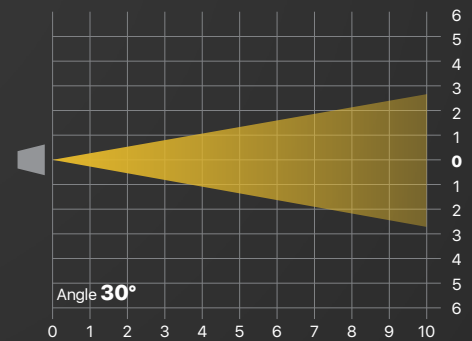

Optic: Lens Tube Profile 50°

Distance (m)	1	2	3	4	5	6	7	8	9	10	
Luminous Emitance (lux)	3.000K	1.512	378	168	95	60	42	31	24	19	15
	5.600K	1.683	421	187	105	67	47	34	26	21	17
Diameter ø (m)	0,91	1,82	2,73	3,65	4,56	5,47	6,38	7,29	8,20	9,11	
3.200K	CRI 96	TLCI 99									
5.000K	CRI 97	TLCI 99									

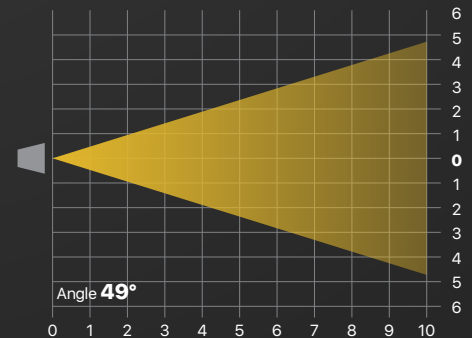

PHOTOMETRICAL DATA

Mini LEDko Profile Fixed White (High CRI)

Optic: Zoom Profile 15°-35° - Narrow Zoom

Distance (m)	1	2	3	4	5	6	7	8	9	10	
Luminous Emitance (lux)	3.000K	12.834	3.209	1.426	802	513	357	262	201	158	128
	5.600K	14.733	3.683	1.637	921	589	409	301	230	182	147
Diameter ø (m)	0.25	0.49	0.74	0.98	1.23	1.47	1.72	1.96	2.21	2.46	
3.200K	CRI 96	TLCI 99									
5.000K	CRI 97	TLCI 99									

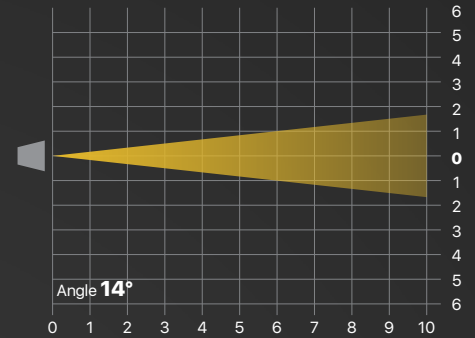

Optic: Zoom Profile 15°-35° - Medium Zoom

Distance (m)	1	2	3	4	5	6	7	8	9	10	
Luminous Emitance (lux)	3.000K	4.788	1.197	532	299	192	133	98	75	59	48
	5.600K	6.012	1.503	668	376	240	167	123	94	74	60
Diameter ø (m)	0.44	0.89	1.33	1.77	2.22	2.66	3.10	3.55	3.99	4.43	
3.200K	CRI 97	TLCI 98									
5.000K	CRI 99	TLCI 99									

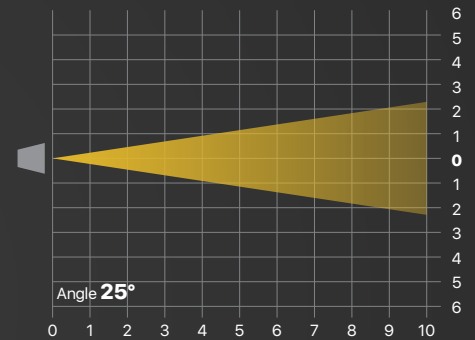

Optic: Zoom Profile 15°-35° - Wide Zoom

Distance (m)	1	2	3	4	5	6	7	8	9	10	
Luminous Emitance (lux)	3.000K	2.574	644	286	161	103	72	53	40	32	26
	5.600K	3.258	815	362	204	130	91	66	51	40	33
Diameter ø (m)	0.63	1.26	1.89	2.52	3.15	3.78	4.41	5.04	5.68	6.31	
3.200K	CRI 97	TLCI 99									
5.000K	CRI 98	TLCI 99									

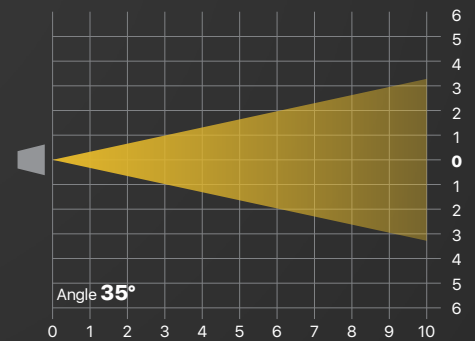

PHOTOMETRICAL DATA

Mini LEDko Profile Fixed White CRI 80

Optic: Lens Tube Profile 19°

Distance (m)	1	2	3	4	5	6	7	8	9	10	
Luminous Emitance (lux)	4.000K	12.656	3.164	1.406	791	506	352	258	198	156	127
	5.600K	n.a.	n.a.	n.a.	n.a.	n.a.	n.a.	n.a.	n.a.	n.a.	n.a.
Diameter ø (m)	0,30	0,60	0,90	1,20	1,49	1,79	2,09	2,39	2,69	2,99	
4.000K	CRI 80	TLCI 64									

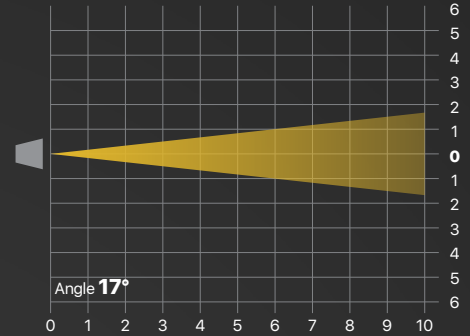

Optic: Lens Tube Profile 26°

Distance (m)	1	2	3	4	5	6	7	8	9	10	
Luminous Emitance (lux)	4.000K	7.218	1.805	802	451	289	201	147	113	89	72
	5.600K	n.a.	n.a.	n.a.	n.a.	n.a.	n.a.	n.a.	n.a.	n.a.	n.a.
Diameter ø (m)	0,41	0,81	1,22	1,63	2,03	2,44	2,85	3,26	3,66	4,07	
4.000K	CRI 80	TLCI 64									

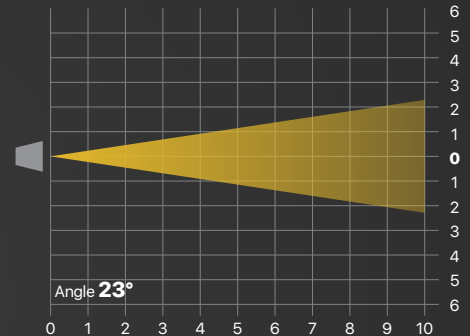

Optic: Lens Tube Profile 36°

Distance (m)	1	2	3	4	5	6	7	8	9	10	
Luminous Emitance (lux)	4.000K	4.435	1.109	493	277	177	123	91	69	55	44
	5.600K	n.a.	n.a.	n.a.	n.a.	n.a.	n.a.	n.a.	n.a.	n.a.	n.a.
Diameter ø (m)	0,54	1,07	1,61	2,14	2,68	3,22	3,75	4,29	4,82	5,36	
4.000K	CRI 80	TLCI 64									

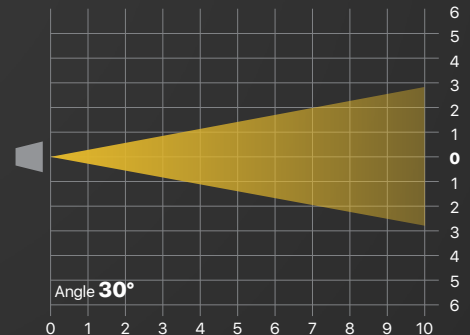

Optic: Lens Tube Profile 50°

Distance (m)	1	2	3	4	5	6	7	8	9	10	
Luminous Emitance (lux)	4.000K	2.187	547	243	137	87	61	45	34	27	22
	5.600K	n.a.	n.a.	n.a.	n.a.	n.a.	n.a.	n.a.	n.a.	n.a.	n.a.
Diameter ø (m)	0,91	1,82	2,73	3,65	4,56	5,47	6,38	7,29	8,20	9,11	
4.000K	CRI 80	TLCI 64									

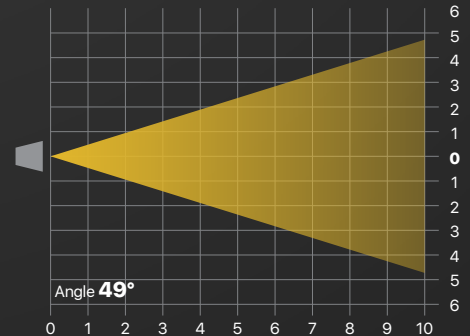

PHOTOMETRICAL DATA

Mini LEDko Profile VariWhite

Optic: Lens Tube Profile 19°

Distance (m)	1	2	3	4	5	6	7	8	9	10	
Luminous Emitance (lux)	3.200K	5136	1284	571	321	205	143	105	80	63	51
	5.000K	5884	1471	654	368	235	163	120	92	73	59
Diameter ø (m)	0,32	0,63	0,95	1,27	1,58	1,90	2,22	2,53	2,85	3,17	
3.200K	CRI 93	TLCI 94									
5.000K	CRI 94	TLCI 96									

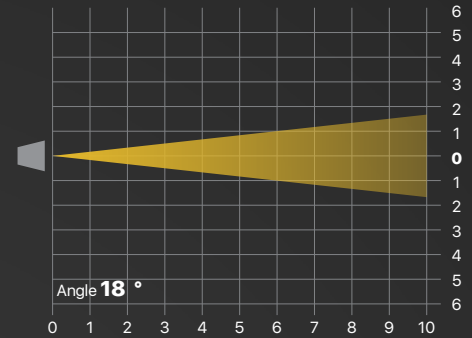

Optic: Lens Tube Profile 26°

Distance (m)	1	2	3	4	5	6	7	8	9	10	
Luminous Emitance (lux)	3.200K	3012	753	335	188	120	84	61	47	37	30
	5.000K	3648	912	405	228	146	101	74	57	45	36
Diameter ø (m)	0,43	0,85	1,28	1,70	2,13	2,55	2,98	3,40	3,83	4,25	
3.200K	CRI 93	TLCI 95									
5.000K	CRI 95	TLCI 96									

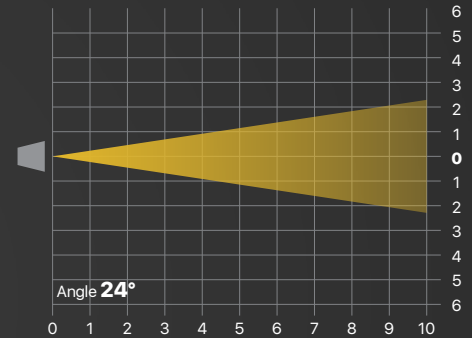

Optic: Lens Tube Profile 36°

Distance (m)	1	2	3	4	5	6	7	8	9	10	
Luminous Emitance (lux)	3.200K	1848	462	205	116	74	51	38	29	23	18
	5.000K	2036	509	226	127	81	57	42	32	25	20
Diameter ø (m)	0,55	1,11	1,66	2,22	2,77	3,33	3,88	4,44	4,99	5,55	
3.200K	CRI 93	TLCI 95									
5.000K	CRI 95	TLCI 96									

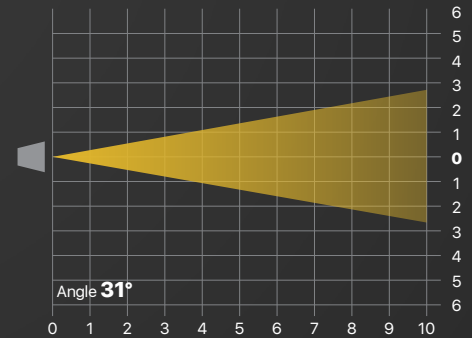

Optic: Lens Tube Profile 50°

Distance (m)	1	2	3	4	5	6	7	8	9	10	
Luminous Emitance (lux)	3.200K	832	208	92	52	33	23	17	13	10	8
	5.000K	968	242	108	61	39	27	20	15	12	10
Diameter ø (m)	0,93	1,87	2,80	3,73	4,66	5,60	6,53	7,46	8,39	9,33	
3.200K	CRI 93	TLCI 95									
5.000K	CRI 94	TLCI 96									

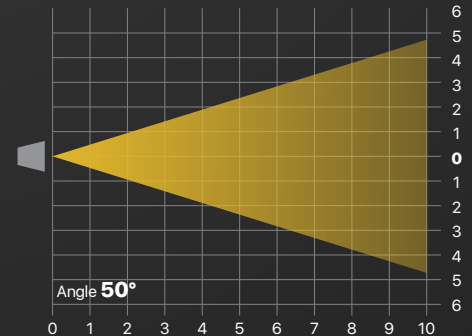

Mini LEDko Profile VariWhite

Optic: Zoom Profile 14° - Narrow Zoom

Distance (m)	1	2	3	4	5	6	7	8	9	10	
Luminous Emitance (lux)	3.200K	6000	1500	667	375	240	167	122	94	74	60
	5.000K	7016	1754	780	439	281	195	143	110	87	70
Diameter ø (m)	0.25	0.49	0.74	0.98	1.23	1.47	1.72	1.96	2.21	2.46	
3.200K	CRI 92	TLCI 95									
5.000K	CRI 94	TLCI 96									

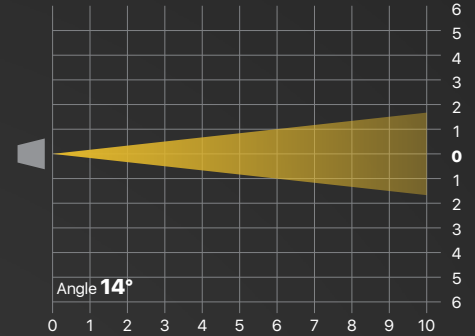

Optic: Zoom Profile 24° - Medium Zoom

Distance (m)	1	2	3	4	5	6	7	8	9	10	
Luminous Emitance (lux)	3.200K	3212	803	357	201	128	89	66	50	40	32
	5.000K	3424	856	380	214	137	95	70	54	42	34
Diameter ø (m)	0.43	0.85	1.28	1.70	2.13	2.55	2.98	3.40	3.83	4.25	
3.200K	CRI 92	TLCI 95									
5.000K	CRI 95	TLCI 96									

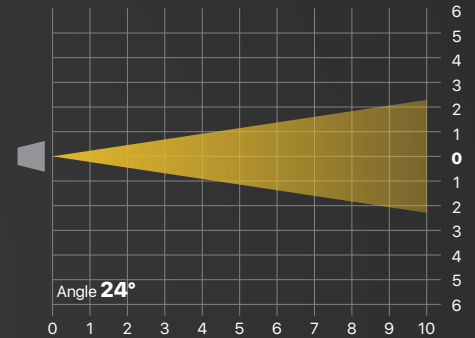

Optic: Zoom Profile 34° - Wide Zoom

Distance (m)	1	2	3	4	5	6	7	8	9	10	
Luminous Emitance (lux)	3.200K	1708	427	190	107	68	47	35	27	21	17
	5.000K	1812	453	201	113	72	50	37	28	22	18
Diameter ø (m)	0.61	1.22	1.83	2.45	3.06	3.67	4.28	4.89	5.50	6.11	
3.200K	CRI 92	TLCI 95									
5.000K	CRI 94	TLCI 96									

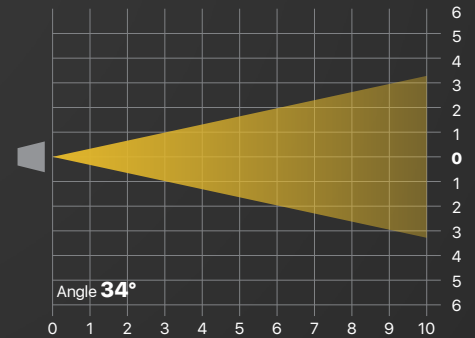

PHOTOMETRICAL DATA

Mini LEDko Profile VariWhite 36° Lens Tube

3200K Test Report

BASIC

CCT	: 3278 K
x	: 0,4135
y	: 0,3853
LambdaD	: 583 nm
LambdaP	: 625 nm

Spectrum

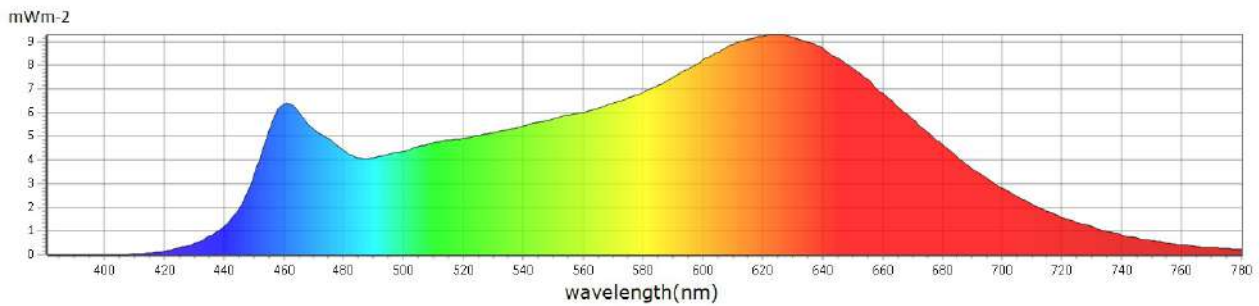

CIE1931

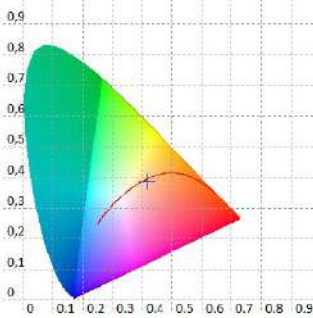

CIE1976

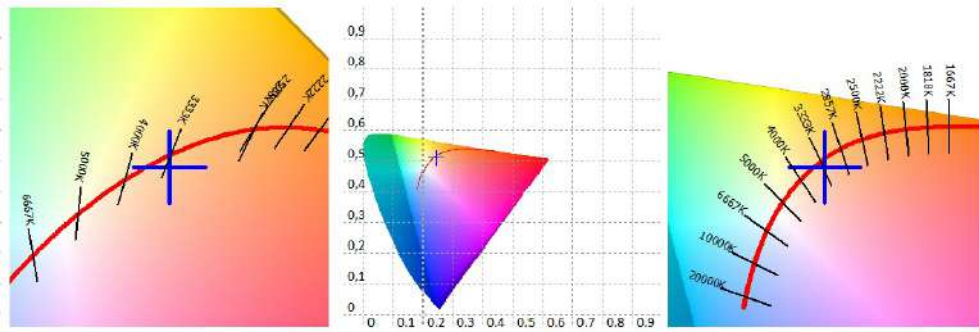

Features

CCT : 3278 K	x10 : 0,4176	delta-x : -0,0049	LambdaD : 583 nm	PPFD : 7,591 $\mu\text{molm}^{-2}\text{s}^{-1}$	S/P : 1,69	R3 : 92,4	R10 : 87,3
LUX : 462,9 lx	y10 : 0,3885	delta-y : -0,0116	LambdaP : 625 nm	PFD : 8,092 $\mu\text{molm}^{-2}\text{s}^{-1}$	IRR : 1,653	R4 : 94,8	R11 : 97,3
I-Time : 28000 us	u'10 : 0,2447	delta-u' : 0,0017	Purity : 39,89%	PFD-B : 1,098 $\mu\text{molm}^{-2}\text{s}^{-1}$	CQS : 93,4	R5 : 94,7	R12 : 77,9
x : 0,4135	v'10 : 0,5122	delta-v' : -0,0055	fc : 43,02	PFD-G : 2,751 $\mu\text{molm}^{-2}\text{s}^{-1}$	CRI : 92,5	R6 : 88,7	R13 : 94,8
y : 0,3853	X : 496,84	Duv : -0,0041	Rf : 89,1	PFD-R : 3,742 $\mu\text{molm}^{-2}\text{s}^{-1}$	TLCI : 94,8	R7 : 89,8	R14 : 96,4
u' : 0,2434	Y : 462,91	MEL : 325,4 lx	Rg : 96,7	PFD-UV : 0,0000 $\mu\text{molm}^{-2}\text{s}^{-1}$	R1 : 96,2	R8 : 90,0	R15 : 96,9
v' : 0,5102	Z : 241,73	LambdaPV : 9,283	GAI : 68,0	PFD-FR : 0,5006 $\mu\text{molm}^{-2}\text{s}^{-1}$	R2 : 93,6	R9 : 86,7	

PHOTOMETRICAL DATA

Mini LEDko Profile VariWhite 36° Lens Tube

3200K Test Report

■ CRI: 92,51

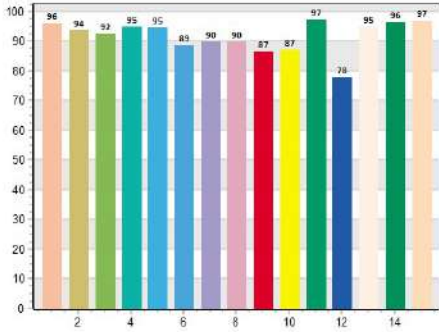

■ CQS: 93,38

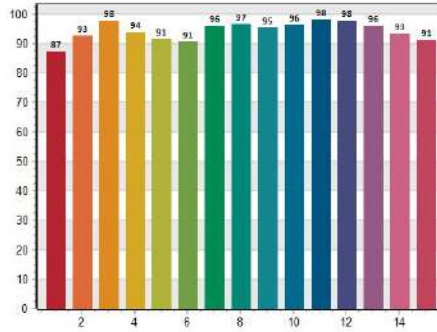

■ CRI-2

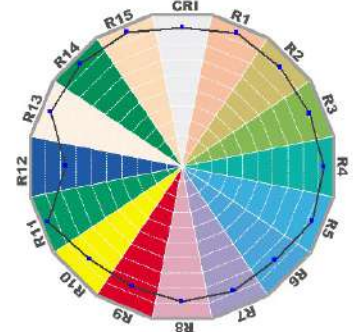

■ TM30: 89,08

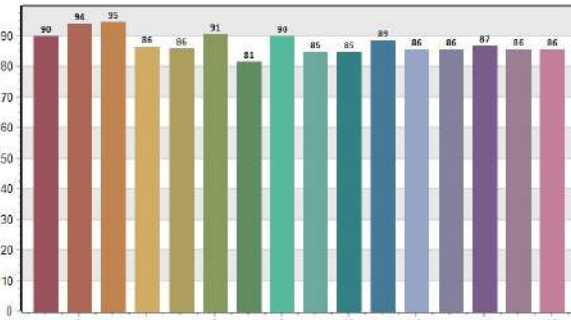

■ TLCI: 94,75

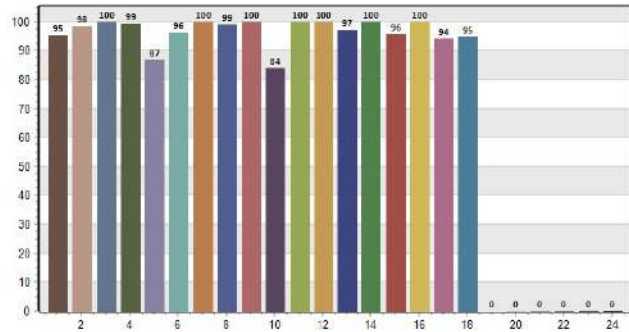

CRI values, only R1-R8 are used to calculate final CRI

R1	R2	R3	R4	R5	R6	R7	R8	R9	R10	R11	R12	R13	R14	R15
96,2	93,6	92,4	94,8	94,7	89,7	89,8	90,0	86,7	87,3	97,3	77,9	94,8	96,4	96,9

TM30 C values, 16 binned values out of total of 99 C values

C1	C2	C3	C4	C5	C6	C7	C8	C9	C10	C11	C12	C13	C14	C15	C16
89,8	94,1	94,5	86,4	85,9	90,5	81,5	89,8	84,6	84,7	88,6	85,5	85,7	86,7	85,5	85,6

CQS Q values

Q1	Q2	Q3	Q4	Q5	Q6	Q7	Q8	Q9	Q10	Q11	Q12	Q13	Q14	Q15
87,4	92,6	97,7	94,0	91,4	90,6	96,0	96,6	95,3	96,2	98,1	97,8	96,0	93,2	91,2

PHOTOMETRICAL DATA

Mini LEDko Profile VariWhite 36° Lens Tube

5000K Test Report

BASIC

CCT	: 5014 K
x	: 0,3444
y	: 0,3475
LambdaD	: 575 nm
LambdaP	: 457 nm

Spectrum

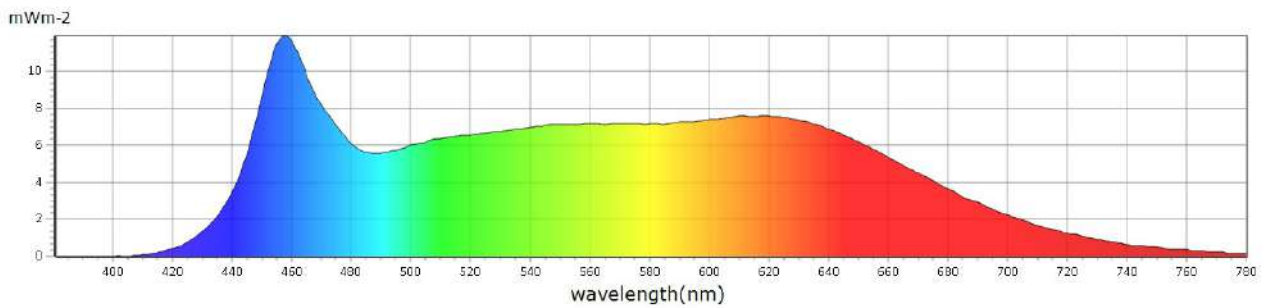

CIE1931

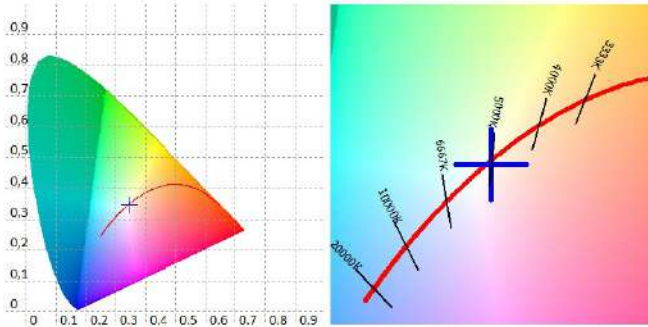

CIE1976

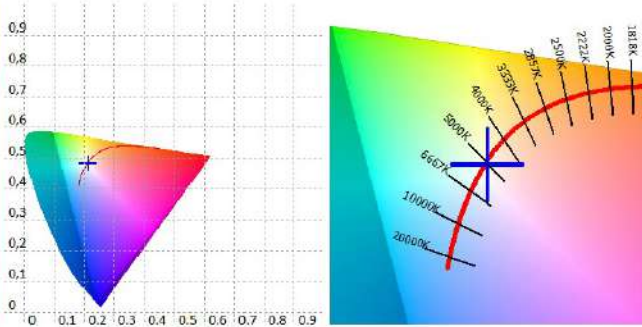

Features

CCT : 5014 K	x10 : 0,3479	delta-x : -0,0004	LambdaD : 575 nm	PPFD : 8,121 $\mu\text{mol}\cdot\text{m}^{-2}\cdot\text{s}^{-1}$	S/P : 2,17	R3 : 96,9	R10 : 95,3
LUX : 509,7 lx	y10 : 0,3521	delta-y : -0,0038	LambdaP : 457 nm	PFD : 8,517 $\mu\text{mol}\cdot\text{m}^{-2}\cdot\text{s}^{-1}$	IRR : 1,813	R4 : 94,0	R11 : 96,2
I-Time : 16000 us	u'10 : 0,2131	delta-u' : 0,0012	Purity : 7,58%	PFD-B : 1,911 $\mu\text{mol}\cdot\text{m}^{-2}\cdot\text{s}^{-1}$	CQS : 93,5	R5 : 95,4	R12 : 77,5
x : 0,3444	v'10 : 0,4853	delta-v' : -0,0019	fc : 47,37	PFD-G : 3,193 $\mu\text{mol}\cdot\text{m}^{-2}\cdot\text{s}^{-1}$	CRI : 94,8	R6 : 93,6	R13 : 97,5
y : 0,3475	X : 505,07	Duv : -0,0018	Rf : 91,0	PFD-R : 3,017 $\mu\text{mol}\cdot\text{m}^{-2}\cdot\text{s}^{-1}$	TLCI : 96,0	R7 : 92,6	R14 : 98,3
u' : 0,2125	Y : 509,68	MEL : 486,7 lx	Rg : 98,0	PFD-UV : 0,0004 $\mu\text{mol}\cdot\text{m}^{-2}\cdot\text{s}^{-1}$	R1 : 97,0	R8 : 92,1	R15 : 96,2
v' : 0,4825	Z : 451,93	LambdaPV : 11,93	GAI : 89,6	PFD-FR : 0,3955 $\mu\text{mol}\cdot\text{m}^{-2}\cdot\text{s}^{-1}$	R2 : 96,7	R9 : 87,9	

PHOTOMETRICAL DATA

Mini LEDko Profile VariWhite 36° Lens Tube

5000K Test Report

■ CRI: 94,79

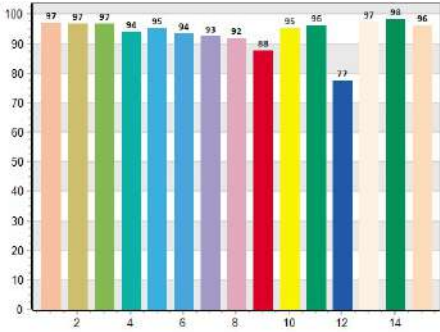

■ CQS: 93,53

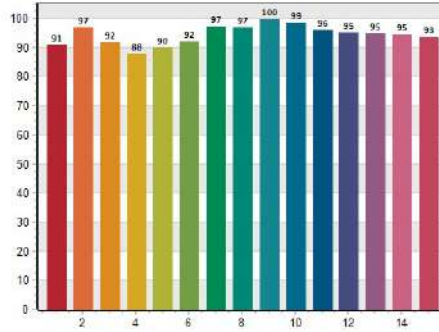

■ CRI-2

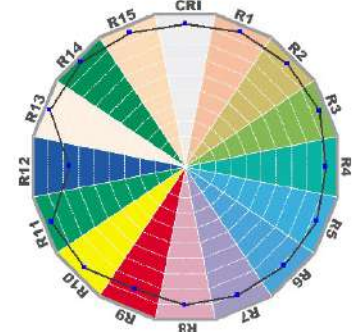

■ TM30: 90,97

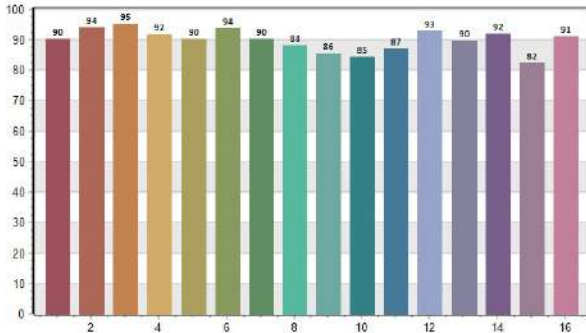

■ TLCI: 95,97

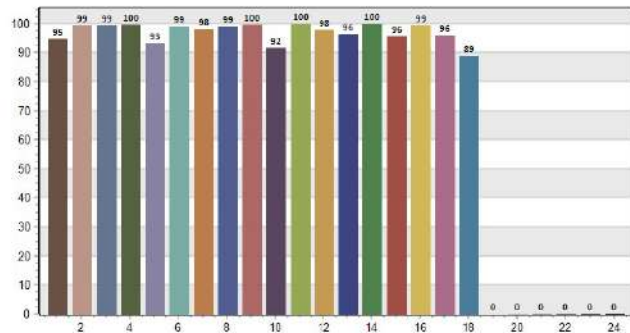

CRI values, only R1-R8 are used to calculate final CRI

R1	R2	R3	R4	R5	R6	R7	R8	R9	R10	R11	R12	R13	R14	R15
97,0	96,7	96,5	94,0	95,4	93,6	92,6	92,1	87,9	95,5	96,2	77,5	97,5	98,3	96,2

TM30 C values, 16 binned values out of total of 99 C values

C1	C2	C3	C4	C5	C6	C7	C8	C9	C10	C11	C12	C13	C14	C15	C16
90,3	94,0	95,3	91,7	90,2	93,8	90,2	88,4	85,5	84,6	87,0	93,0	89,8	92,2	82,4	91,1

CQS Q values

Q1	Q2	Q3	Q4	Q5	Q6	Q7	Q8	Q9	Q10	Q11	Q12	Q13	Q14	Q15
90,9	97,1	91,7	87,9	89,9	92,1	97,2	97,1	99,7	98,6	96,2	95,1	94,7	94,6	93,5



Coemar Lighting s.r.l.

Via Carpenedolo 90
46043 Castiglione delle Stiviere, Mantova, Italy
phone. +39 0376/1514412 - fax +39 0376/1514380
info@coemar.com

Coemar reserves the right to change specifications without prior notice