

ALEX - III7

COMPACT - 2000/2500 W TUNGSTEN



- **Type:** Followspot
- **Source:** 2000/2500 W Tungsten
- **Optics:** 7° to 14,5° zoom

Followspot

Television's tungsten favourite

The Alex long throw tungsten followspot blends well with conventional theatre lighting and maintains the flat beam and constant colour temperature during dimming which is so important to sensitive camera equipment. Ideal for television studios, opera houses and ballets.

Features

- **Fully closing iris cassette:** Removable for fast, easy replacement; protective backplate for extended lifespan
- **Universal adjustable gobo holder:** A-size glass and metal gobos
- **Ergonomic dimmer control:** One-handed dim, pan and tilt. Dimmer control can be adjusted to suit the operator's preference
- **Smooth dimmer shutter:** Retains flat beam and colour temperature when dimming
- **Frost filter:** On flip lever for quick soft-edge beam effect
- **Horizontal chopper (optional):** For masking control in TV studios and wide stages
- **Internal glass filter holder:** Long term use of durable coloured, dichroic or textured glass
- **Individually removable colour frame:** Gels replaced easily while colour cassette remains in place
- **Colour changer:** 6-way, self-cancelling boomerang colour-changer
- **Easy focus reference:** Graduated scale on side of lantern; fast and easy refocusing
- **Adjustable yoke (optional):** For optimum overhead positioning
- **Fine balance:** Precision positioning and smooth operation even with the smallest movements
- **Stand:** Perfectly weighted for maximum stability with smooth rotation for optimum performance. Easy set up; triple safety system for extra security

Optical

- **Factory set optical train:** Travels safely within followspot and requires no time-consuming realignment on arrival. Uniform beam on all followspots of same type
- **SX optical system:** Double condenser optics for exceptional optical quality
- **Gobo :** Excellent gobo projection
- **Variable zoom optics:** Sharp focus at every beam angle

Construction

- **Made in France :** Fully manufactured on the premises retaining complete control over all aspects of quality
- **Local ON/OFF switch**
- **G22 socket locking system exclusive to Robert Juliat:** Holds the lamp securely in place to ensure there is no arcing, even when the fixture is pointing vertically downward
- **Bodywork:** Strong sheet metal construction for durability
- **Ergonomic wrap-around handle:** Comfort, safety and practicality from all operating positions
- **Moving parts:** Smooth at all times, even when hot
- **Captive knobs and handles:** Additional security when working at height or in transit
- **Easy access to all parts:** Easy cleaning, re-lamping and maintenance
- **Removable assemblies:** Fast-plug cable connectors and complete component assemblies (mirror, condenser set and lamp house assembly) save maintenance and cleaning time

Picture:1117

DSEN093_1117 - 03/12/2015

Robert Juliat reserves the right to change or alter any of the items detailed on this page, to increase or improve manufacturing techniques without prior notice.

Robert Juliat S.A.S., 32 rue de Beaumont, 60530 Fresnoy-en-Thelle - France
Telephone : +33 (0)3 44 26 51 89 - fax : +33 (0)3 44 26 90 79 - info@robertjuliat.fr
www.robertjuliat.com



ROBERT JULIAT

Source



- **Lamp type:** Tungsten
- **Socket:** G22

Admissible lamps	Power *	Lumen output*	Colour temperature*	Life*
LIF: CP92	2 000 W	52 000 lm	3200K	400 h
LIF: CP91	2 500 W	65 000 lm	3200K	400 h

(*) manufacturers data

Optics

Characteristics

- **Type:** Zoom
- **Beam range:** 7° to 14,5°
- **Focal length:** 283 - 589 mm

Gel filter

- **Shape:** Circle
- **Standard size:** 210 mm (8.3 in)

Gobo

- **Size:** A
- **Material:** Metal
Glass

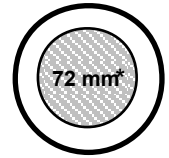

100 mm

*Maximum image size

Photometrics

with LIF: CP91 source

• Optics @ 7°

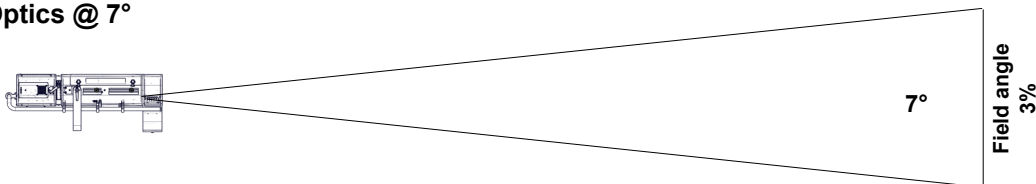

Beam intensity
785 000 cd

Distance	15 m	20 m	25 m	30 m	35 m	40 m
Diameter	1.8 m	2.4 m	3.1 m	3.7 m	4.3 m	4.9 m
Illumination	3 500 lux	2 000 lux	1 300 lux	880 lux	650 lux	500 lux
Distance	50 ft	65 ft	80 ft	100 ft	115 ft	130 ft
Diameter	6.1 ft	8 ft	9.8 ft	12.2 ft	14.1 ft	15.9 ft
Illumination	320 fc	190 fc	130 fc	80 fc	60 fc	47 fc

• Optics @ 14.5°

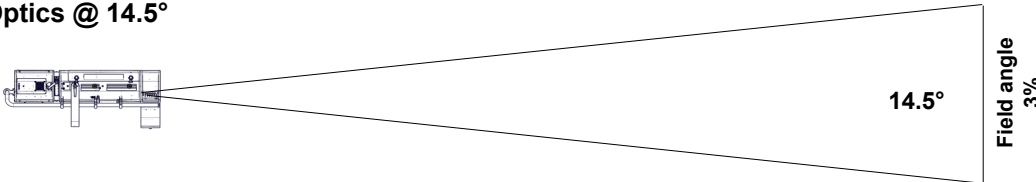

Beam intensity
295 000 cd

Distance	15 m	20 m	25 m	30 m	35 m	40 m
Diameter	3.8 m	5.1 m	6.4 m	7.6 m	8.9 m	10.2 m
Illumination	1 350 lux	740 lux	480 lux	330 lux	250 lux	190 lux
Distance	50 ft	65 ft	80 ft	100 ft	115 ft	130 ft
Diameter	12.7 ft	16.5 ft	20.4 ft	25.4 ft	29.3 ft	33.1 ft
Illumination	120 fc	70 fc	47 fc	30 fc	23 fc	18 fc

Dimensions and weight

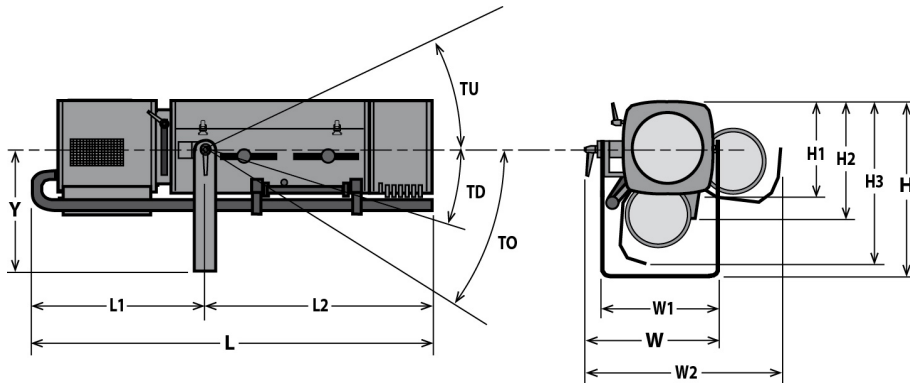

Weight: 30 kg (66 lbs)

Height	Length	Width	Yoke	Tilt	Option
H= 450 mm (17.7 in)	L= 1190 mm (46.9 in)	W= 410 mm (16.1 in)	Y= 325 mm (12.8 in)	TU= 35°	TO= TBD°
H1= 250 mm (9.8 in)	L1= 500 mm (19.7 in)	W1= 350 mm (13.8 in)		TD= 35°	
H2= 320 mm (12.6 in)	L2= 690 mm (27.2 in)	W2= 570 mm (22.4 in)			
H3= 460 mm (18.1 in)					

Shipping

- **Weight :** 35 kg (77 lbs)
- **Volume :** .22 m³ (7.77 ft³)

Installation

- **Minimum distance to illuminated surface:** 2.8 m (9.2 ft)
- **Operating position:**

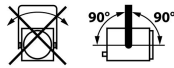

Warranty

- **Period: 2 years**
See General Sales Condition on website

Approvals



Construction

- **Housing:** Steel sheet - Aluminium
- **Colour:** Black
- **Cooling:** Low noise fan
- **Maximum ambient temperature (Ta):** 40°C (104°F)
- **Maximum case temperature (Tc) :** 270°C (518°F)
- **Total heat dissipation:** 6 826 BTU/h
- **Protection rating:** 20

Electrical compatibility

- 230/240 V - 50 Hz
- 115/120 V - 60 Hz

Power input



- **Type:** attached power cord
- **Cable:** H07RNF 3G1.5
- **Length:** 3 m (9,8 ft)
- **Power connector:** CEE 7/7 (2P+E NF/Schuko)





Power consumption

Voltage	Frequency	Current	Power
230 V	50 Hz	9 A	2000 W
230 V	50 Hz	11 A	2500 W









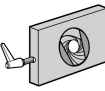

Model











1117	2000/2500 W Tungsten Followspot - G22 socket - 1117 Alex - 7/14,5°
-------------	--

Options

PCP1716A	16A blue 2P+E 6h IEC60309 power connector	
FRO/1117PV	Heavy duty adjustable yoke	
PG80	Ø80mm chopper kit (G80+ GR120+ adaptation kit)	
M210TM	6 ways "push/pull" colour changer	
FC1459	Flight-case for Compact range + GT stand + P.S.U. + accessories - Dim: 1340x710x700mm - Poids: 55 Kg	

Accessories

CCU1	Full closing iris cassette - Weight: 1,33 Kg 1 included	
PF1011	Ø210 mm metal filter holder 6 included	
SGUP	Universal "A" size gobo-holder (metal, glass, frosted glass) 1 included	
VDM100	Ø97mm frosted glass with holder 1 included	
M210B	6 ways "boomerang" colour changer - Weight: 3,36 Kg 1 included	
CP91	CP91 - G22 2500W 230V 400h 3200K lamp	
CP92	CP92 - G22 2000W 230V 400h 3200K lamp	
GT1000	Tripod stand - SWL: 40 Kg - max. height: 1550 mm - Weight: 9,27 Kg	
GT4000	Tripod stand with safety chain - SWL: 130 Kg - max. height: 1030 mm - Weight: 7,91 Kg	
GT4000S	Tripod stand without safety chain - SWL: 130 Kg - max. height: 1030 mm - Weight: 8,65 Kg	
JPP	Monopod stand for overhead followspot - Weight: 3,6 Kg	

T1000	TV spigot with followspots swivel head - Weight: 1,82 Kg	
T4000	Followspot mount for Ø50mm pipe (suspension or overhead) - SWL= 100 Kg - Weight: 4,88 Kg	
CAV700A	Double slot front cassette for 215x215mm accessories - Weight: ,52 Kg	
VD120	120x120mm frosted glass	
FRO/1017PD	Heavy duty adjustable yoke - Weight: 4,33 Kg	
Kit G80	Ø80mm chopper kit (G80+ GR120+ adaptation kit) - Weight: ,69 Kg	
M210T	6 ways "push/pull" colour changer - Weight: 3,67 Kg	
M210TVCL	Light shield for M210T push/pull colour changer - Weight: 1,98 Kg	
Kit TELRAD	Telrad followspot sight with raiser and universal mounting kit - Weight: 1,23 Kg	
FC1459/S	Flight-case for Compact range + GT stand + P.S.U. + accessories - Weight: 55 Kg	
W/GT800	Set of 3 wheels for GT800/1000 stand - Weight: 2,33 Kg	